



Greaney Concrete Products
Advanced equipment & superior products since 1976

450mm Trapped Gully

Approx Weight:
276kg

Drawn By:
TGL

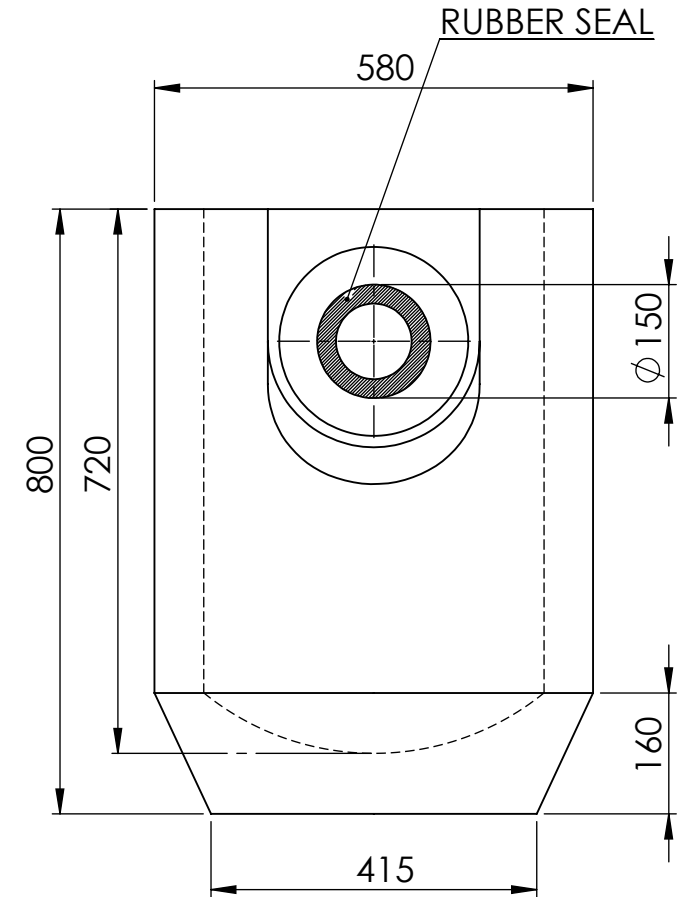
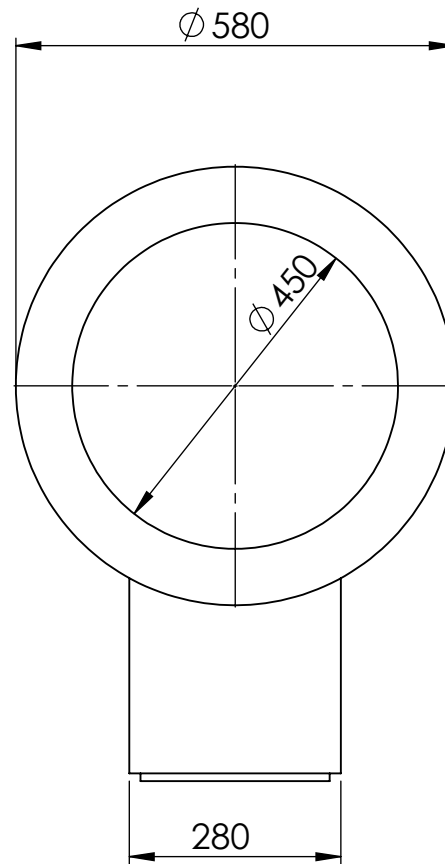
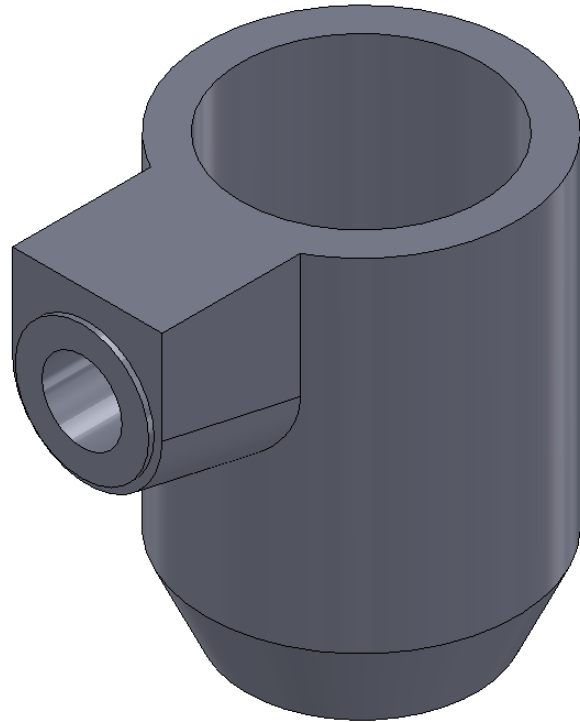

The information contained in this drawing was up to date at the time of going to print. Profile, sizes and weights are given as an indication only. Greaney Concrete Products Ltd reserves the right to modify these at any time without notice.